

## Specification Sheets for Alki Spa Vanities & Linen.

### SPECIFICATION VARIANCES

Dimensions on finished vanities may vary slightly from those shown on these specification sheets due to variability in construction materials.

Our products are engineered to maintain close dimensional tolerances but variability in manufacturing materials can change dimensions slightly (normally within  $\pm 1/8"$  but occasionally up to  $\pm 3/16"$ ).

In most applications these slight variations will have no impact upon installation, appearance or function. However, when planning and finishing a space for a built in vanity, **do not frame or finish the space before measuring the actual cabinet!**

We can not be responsible for any expenses incurred as a result of the end user or contractor not following this guideline.

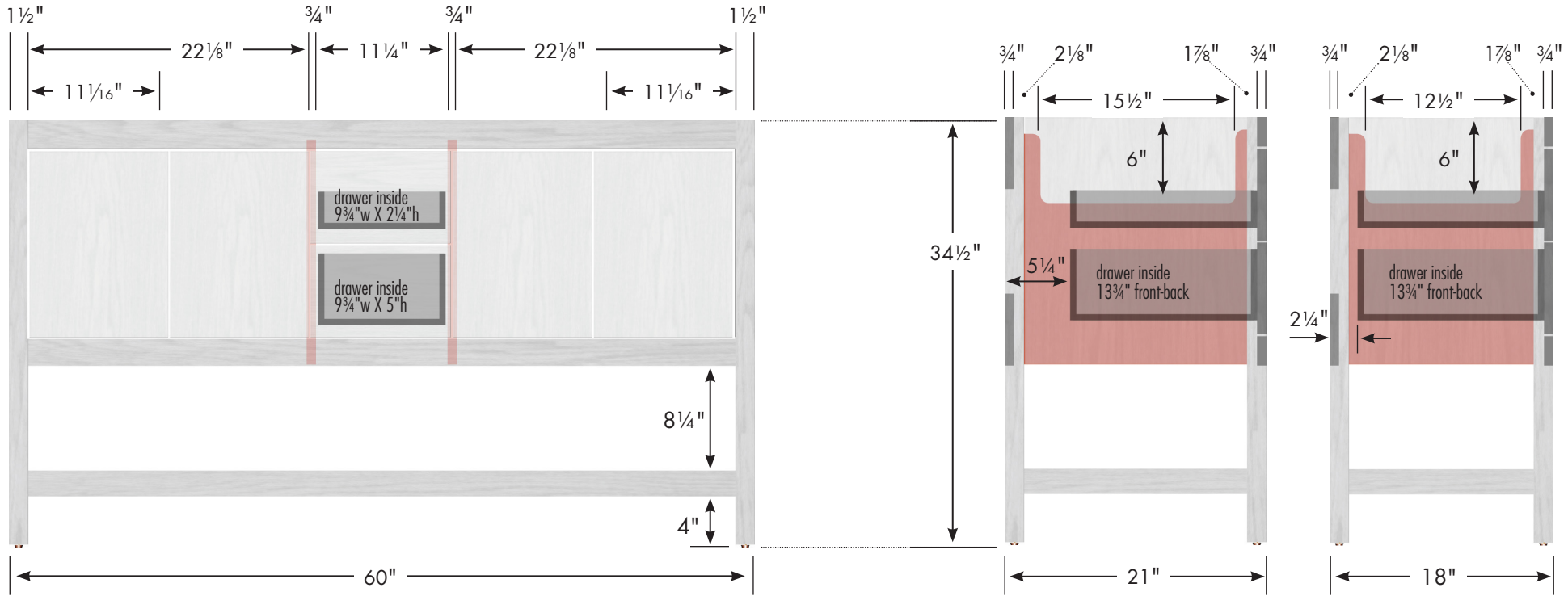

Adjustable/removable shelf under basins behind doors

internal dividers

Vanity back clear openings for plumbing  
(may need to cut adjustable shelf)

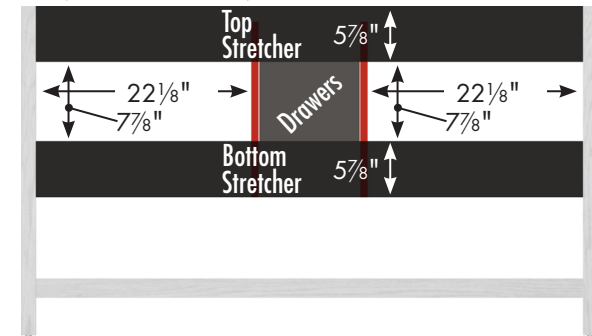

**60" Alki Spa Vanity**  
**Double Basin**  
60" wide  
34½" tall  
21" or 18" front-to-back



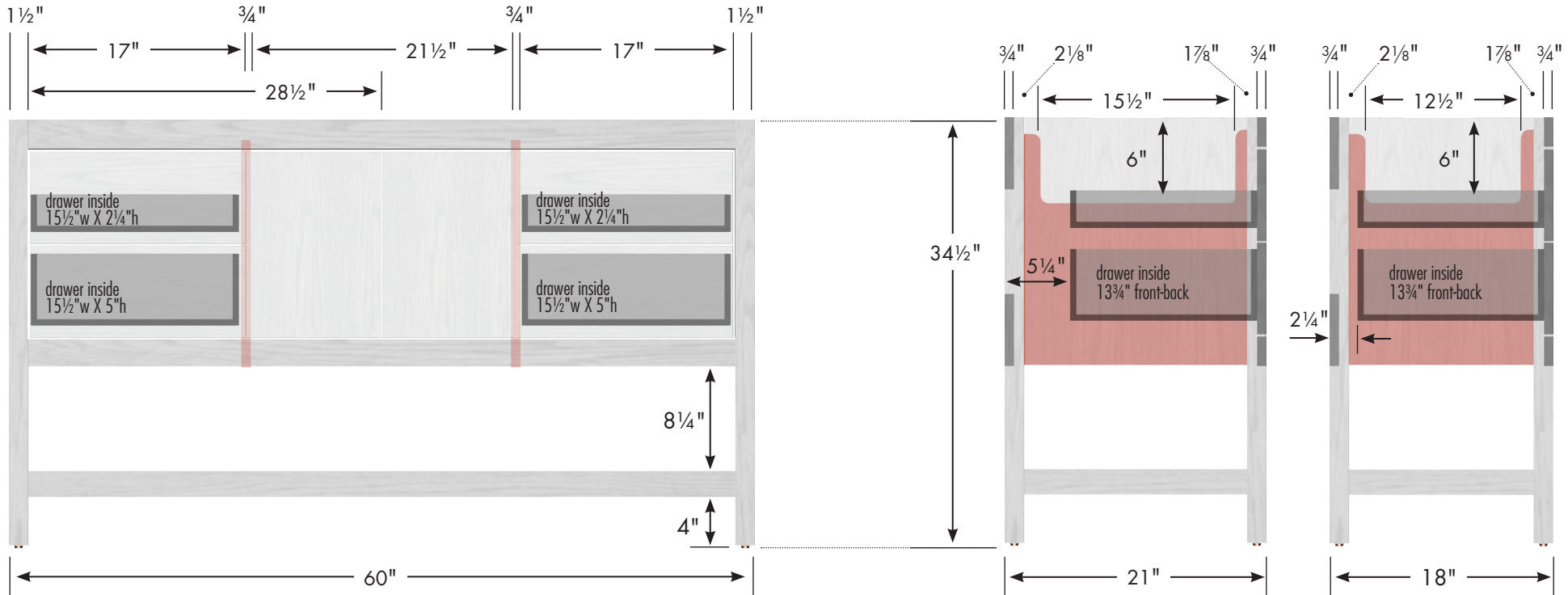

Adjustable/removable shelf under basin behind doors

internal dividers

Vanity back clear openings for plumbing  
(may need to cut adjustable shelf)

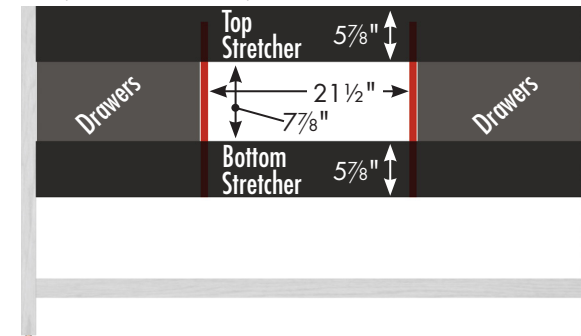

**60" Alki Spa Vanity**  
**Center Basin**  
 60" wide  
 34½" tall  
 21" or 18" front-to-back



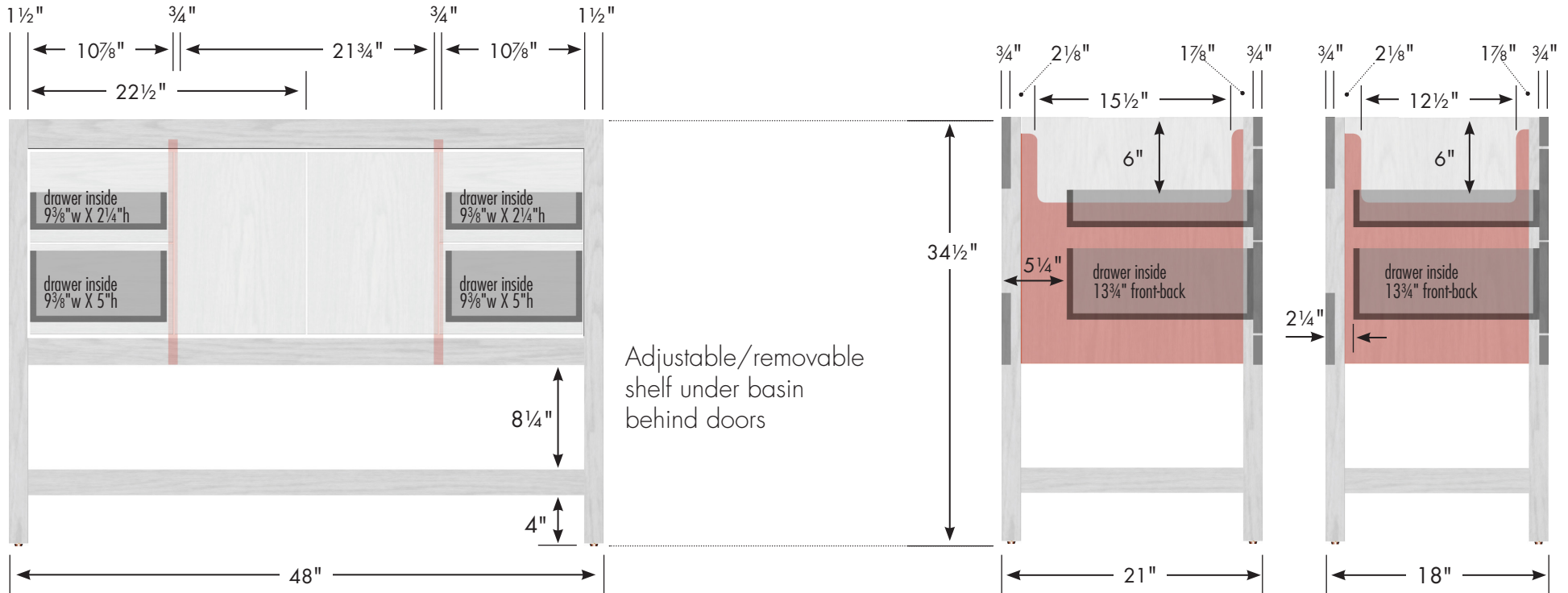

internal dividers

Vanity back clear openings for plumbing  
(may need to cut adjustable shelf)

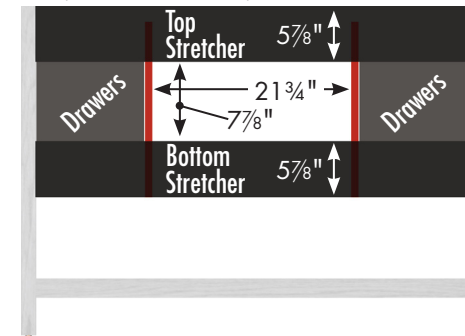

## 48" Alki Spa Vanity

48" wide  
34½" tall  
21" or 18" front-to-back



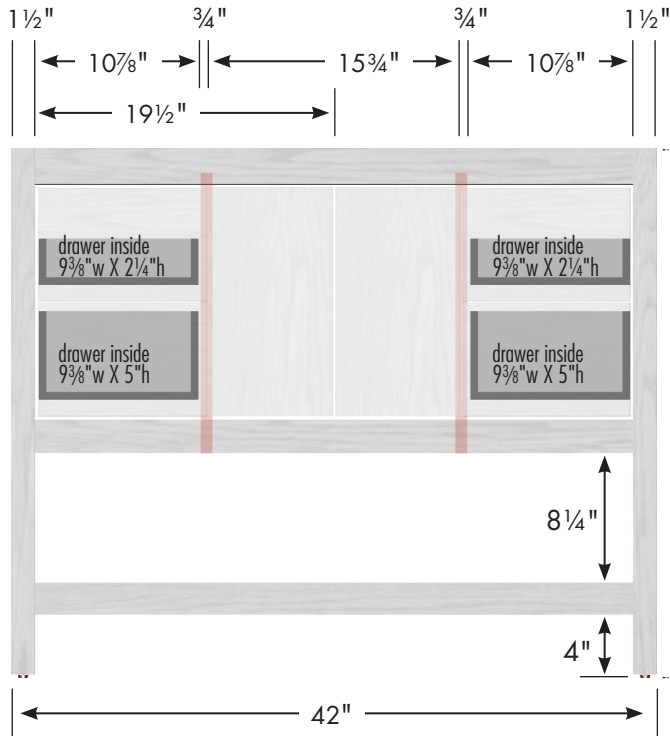

Adjustable/removable shelf under basin behind doors

internal dividers

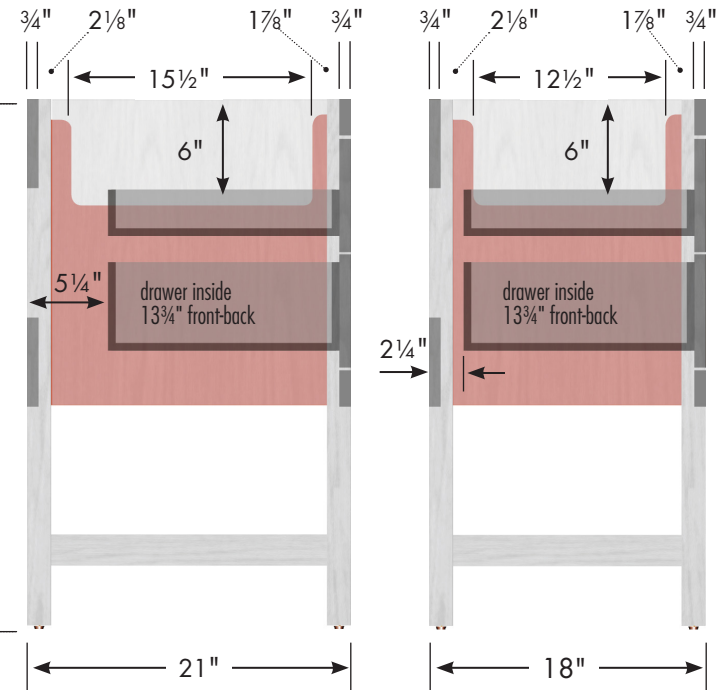

Vanity back clear openings for plumbing (may need to cut adjustable shelf)

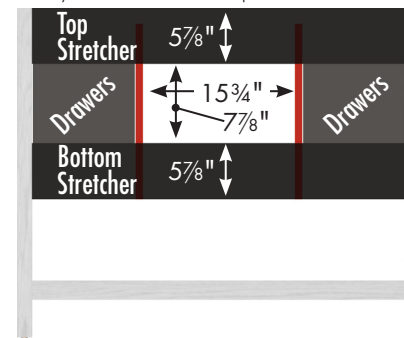

## 42" Alki Spa Vanity

42" wide  
34½" tall  
21" or 18" front-to-back



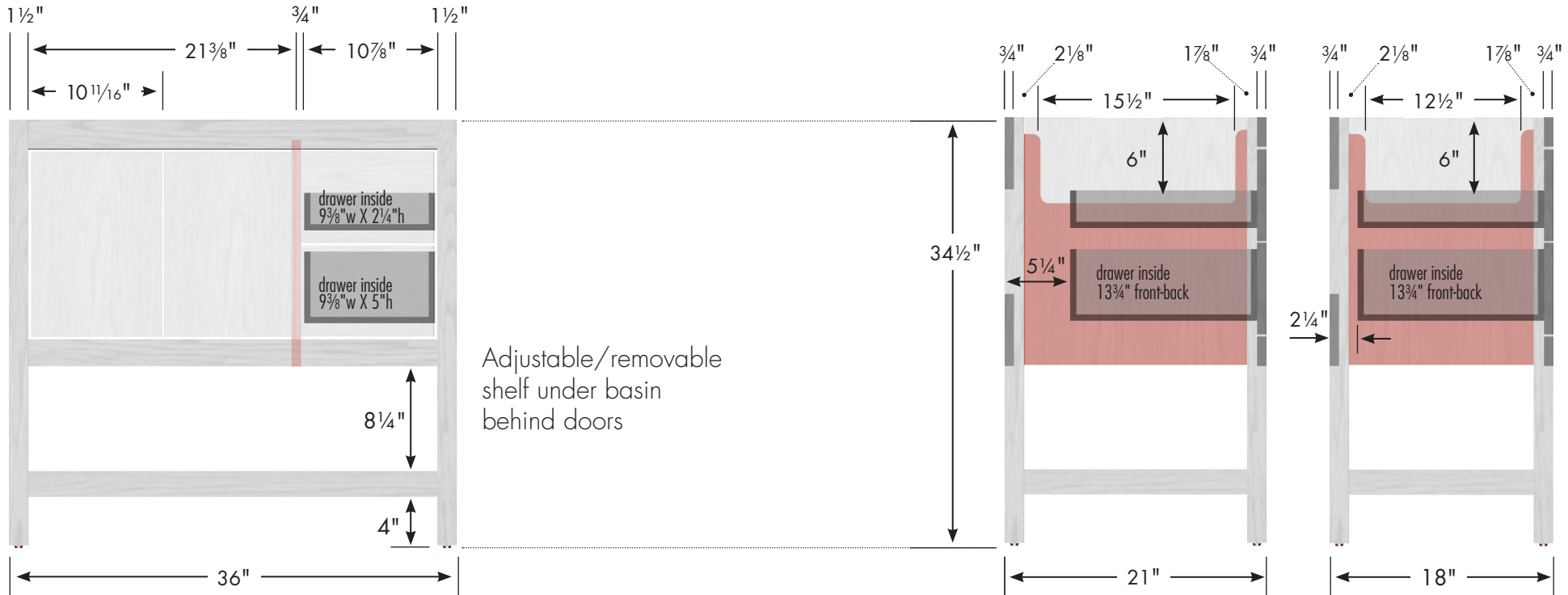

internal dividers

Vanity back clear openings for plumbing  
(may need to cut adjustable shelf)

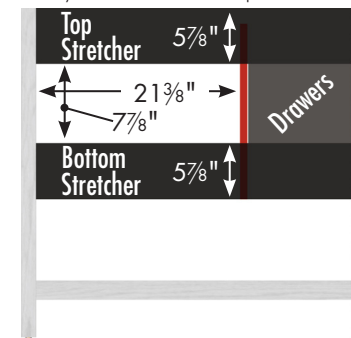

**36" Alki Spa Vanity**  
**Drawers Right**  
 36" wide  
 34½" tall  
 21" or 18" front-to-back



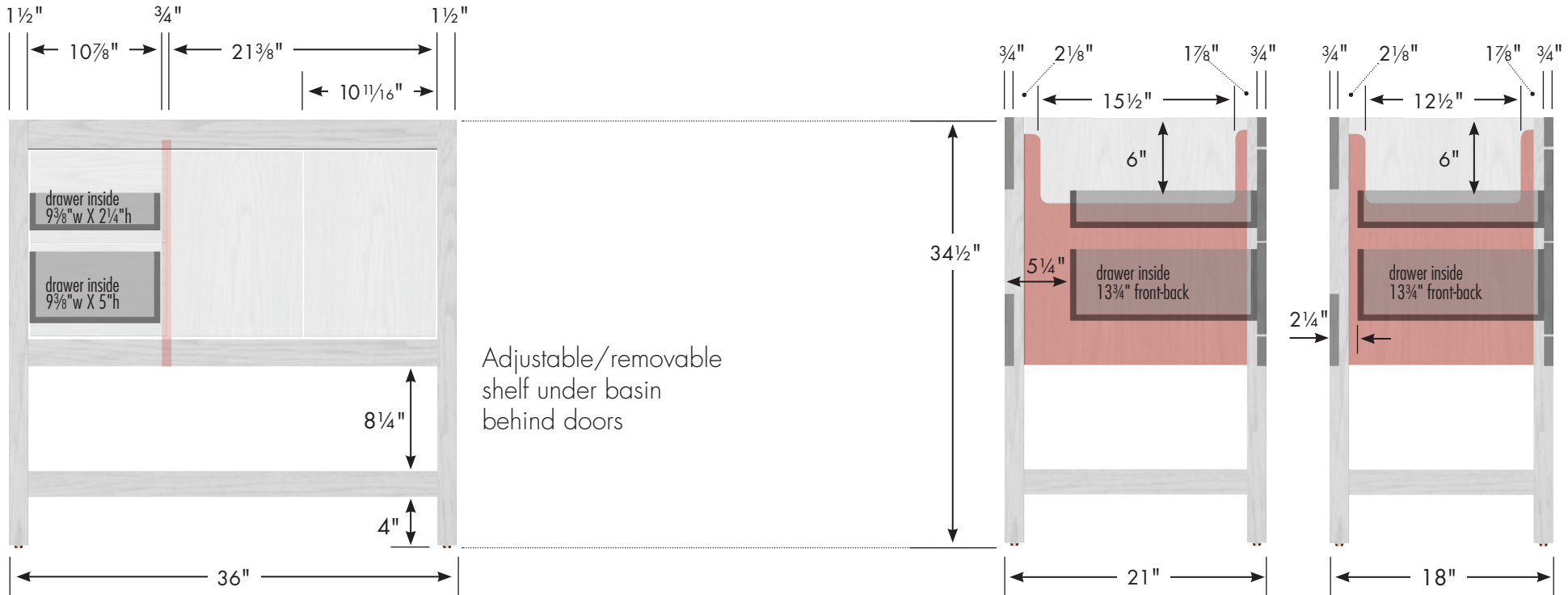

internal dividers

Vanity back clear openings for plumbing  
(may need to cut adjustable shelf)

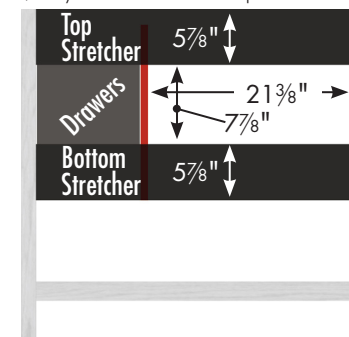

**36" Alki Spa Vanity  
Drawers Left**  
36" wide  
34½" tall  
21" or 18" front-to-back



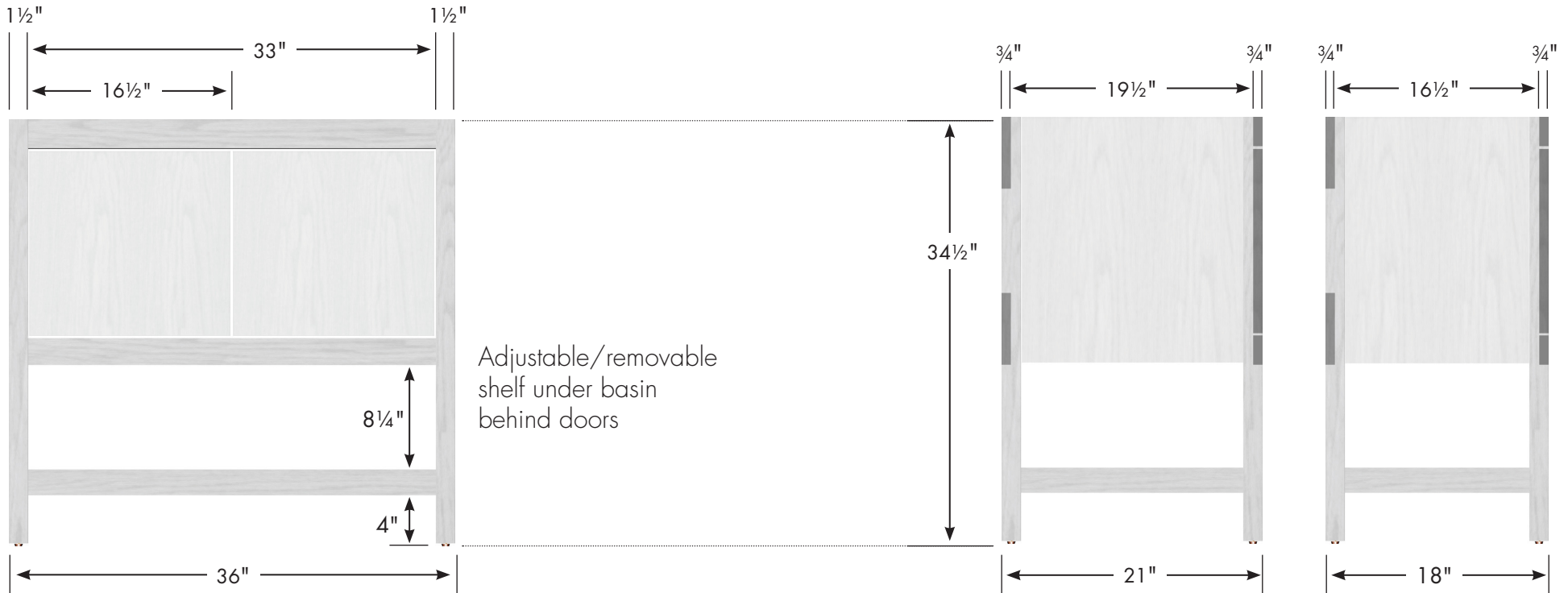

Vanity back clear openings for plumbing  
 (may need to cut adjustable shelf)

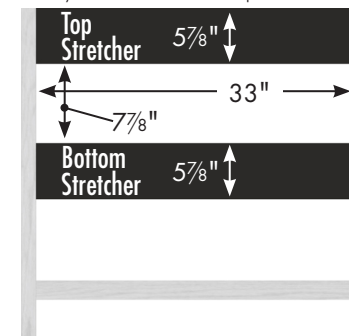

**36" Alki Spa Vanity**  
**No Side Drawers**  
 36" wide  
 34½" tall  
 21" or 18" front-to-back





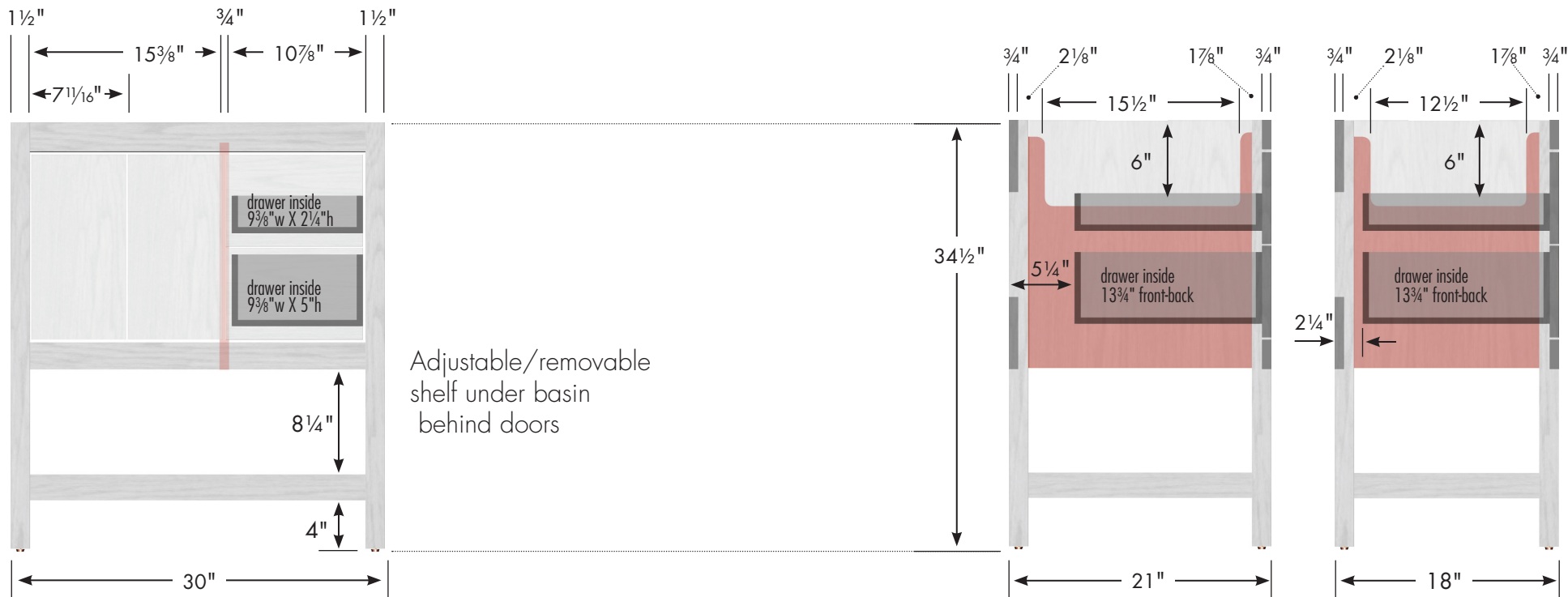

internal dividers

Vanity back clear openings for plumbing  
(may need to cut adjustable shelf)

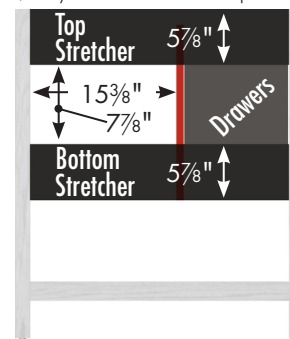

**30" Alki Spa Vanity**  
**Drawers Right**  
 30" wide  
 34½" tall  
 21" or 18" front-to-back



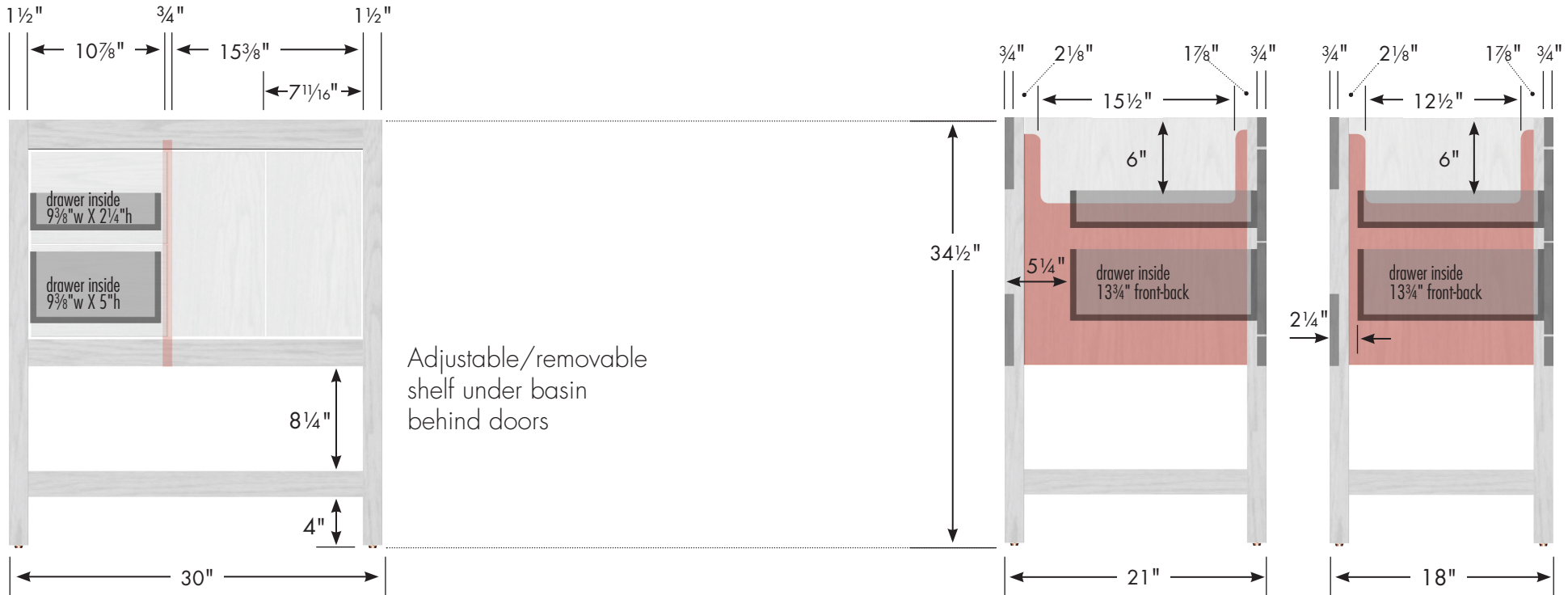

Adjustable/removable shelf under basin behind doors

internal dividers

Vanity back clear openings for plumbing  
(may need to cut adjustable shelf)

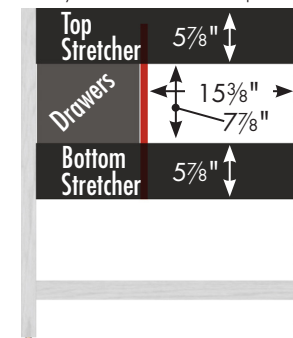

**30" Alki Spa Vanity  
Drawers Left**  
30" wide  
34½" tall  
21" or 18" front-to-back



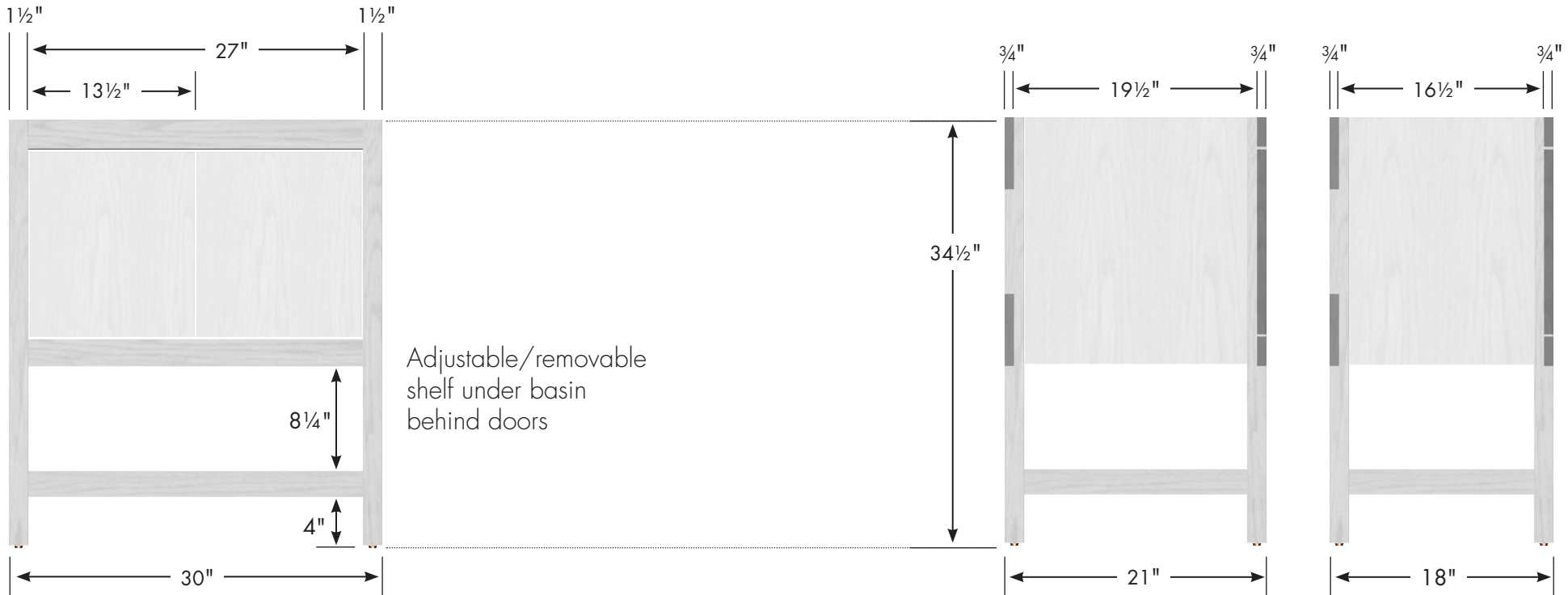

**30" Alki Spa Vanity**  
**No Side Drawers**  
 30" wide  
 34½" tall  
 21" or 18" front-to-back



Vanity back clear openings for plumbing  
 (may need to cut adjustable shelf)

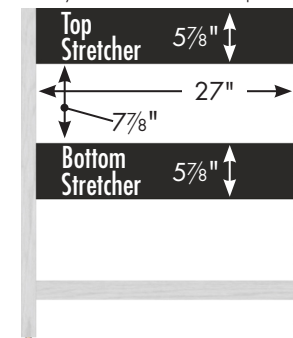

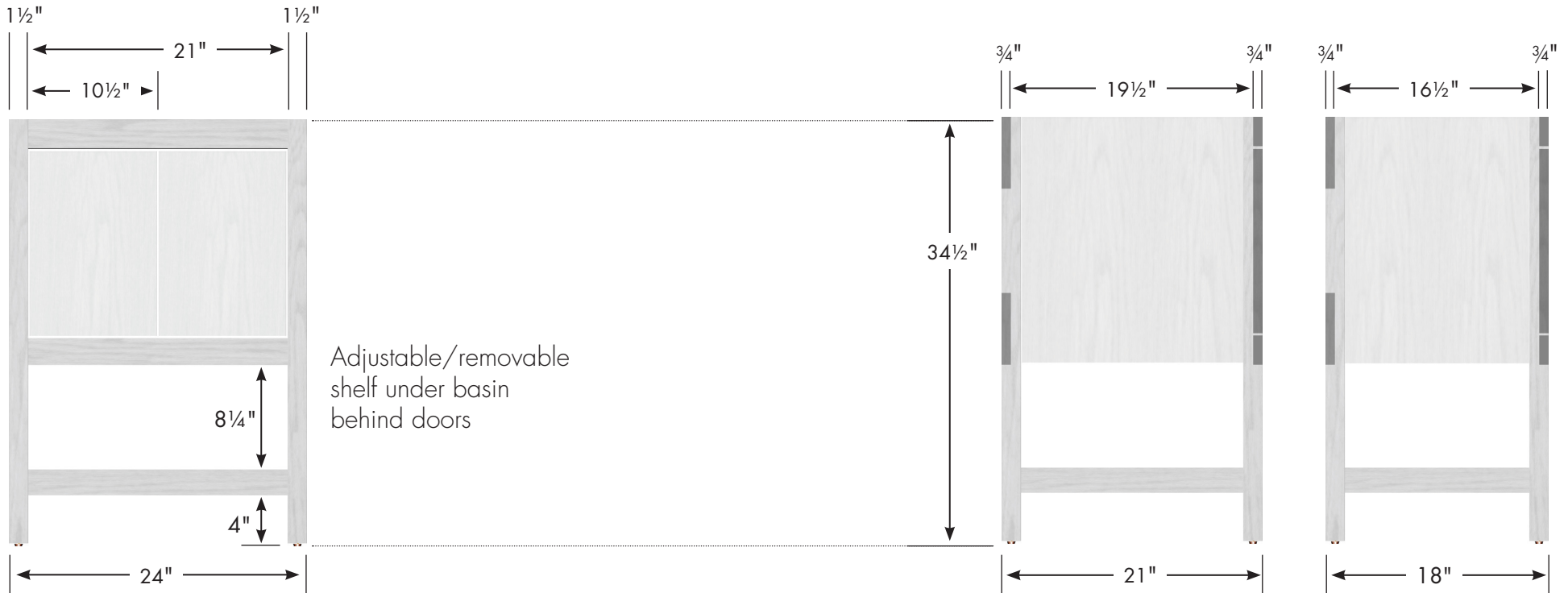

## 24" Alkī Spa Vanity

24" wide  
34½" tall  
21" or 18" front-to-back



Vanity back clear openings for plumbing  
(may need to cut adjustable shelf)

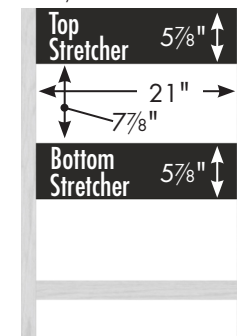

## SPECIAL NOTE

Serious or fatal crushing injuries can occur from a linen cabinet tipping over.

To help prevent tipover:

- Install provided tipover restraint
- Place heaviest items in the lower drawers
- Do not place heavy objects on top of this product
- Never allow children to climb or hang on drawers, doors or shelves
- Do not open more than one drawer at a time.

Use of tipover restraints may only reduce, but not eliminate, the risk of tipover.

We supply attachment hardware with your order but some applications may need different/additional hardware. Manufacturer assumes no liability for improper installation or excessive loads placed on screws, brackets or straps.

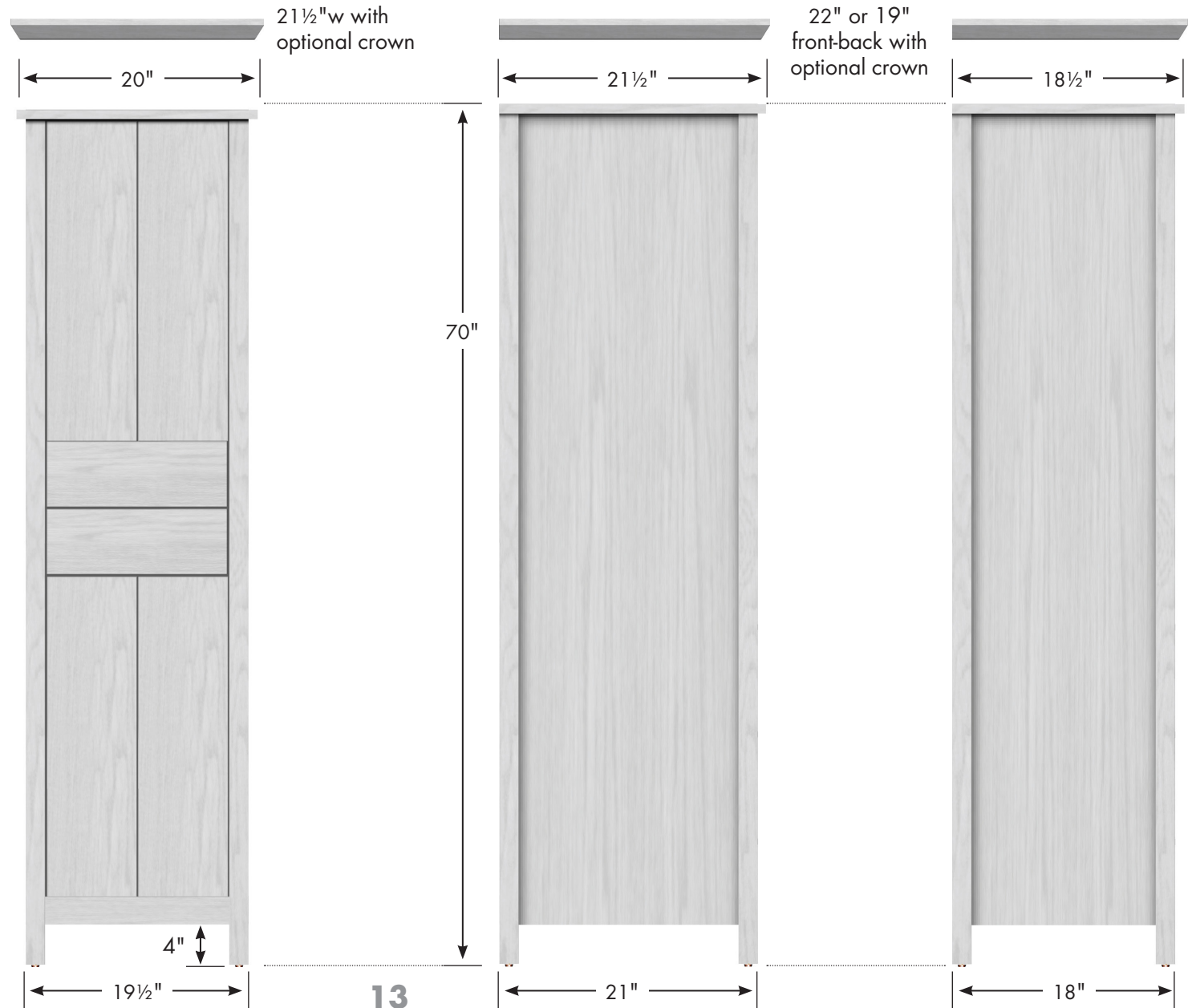

## 19½" Alki Linen

19½" wide  
70" tall

21" or 18" front-to-back  
optional crown adds 1" to height

