

# KOHLER® Faucets <sup>12"</sup>rainhead with Katalyst® air-induction technology, 2.5 gpm K-13690

## Features

- Single-function Rain showerhead.
- MasterClean™ spray nozzles prohibit mineral buildup for easy cleaning.
- Katalyst™ Spray Technology with air induction ball joint.
- Optimized sprayface for maximum performance.
- 2.5 gallon (9.5 L) per minute flow rate.

## Material

- Solid brass construction.

## Installation

- 1/2" - 14 NPT connection.

## Optional Products/Accessories

K-7394 Shower Arm



## Codes/Standards







ASME A112.18.1/CSA B125.1  
DOE - Energy Policy Act 1992

## KOHLER® Faucet Lifetime Limited Warranty

See website for detailed warranty information.

## Available Colors/Finishes

*Color tiles intended for reference only.*

Color	Code	Description
	CP	Polished Chrome
	SN	Vibrant® Polished Nickel
	PGD	Vibrant® Moderne Polished Gold
	BGD	Vibrant® Moderne Brushed Gold
	BN	Vibrant® Brushed Nickel
	BV	Vibrant® Brushed Bronze
	BL	Matte Black

1-800-4KOHLER (1-800-456-4537)

Kohler Co. reserves the right to make revisions without notice to product specifications.

For the most current Specification Sheet, go to [www.kohler.com](http://www.kohler.com).

1-22-2020 05:49 - US/CA/MX

THE BOLD LOOK  
OF **KOHLER**®

**KOHLER** Faucets 12" rainhead with Katalyst® air-induction technology, 2.5 gpm  
**K-13690**

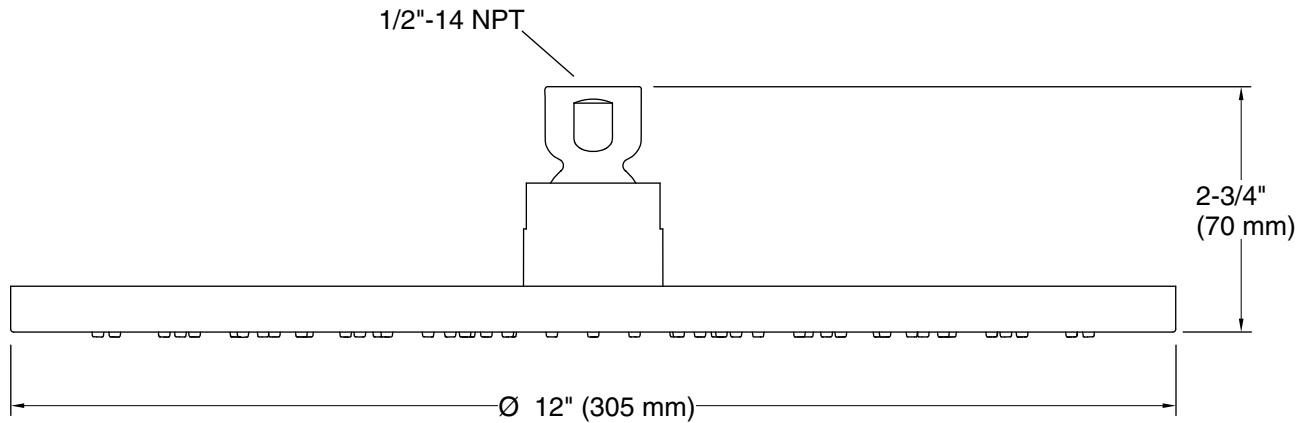

**Technical Information**

All product dimensions are nominal.

**Showerhead/Body Spray:**

Rated maximum flow: 2.5 gal/min (9.5 l/min)

**Notes**

Install this product according to the installation guide.