

LACAVA

LUCE

LUC-W-36

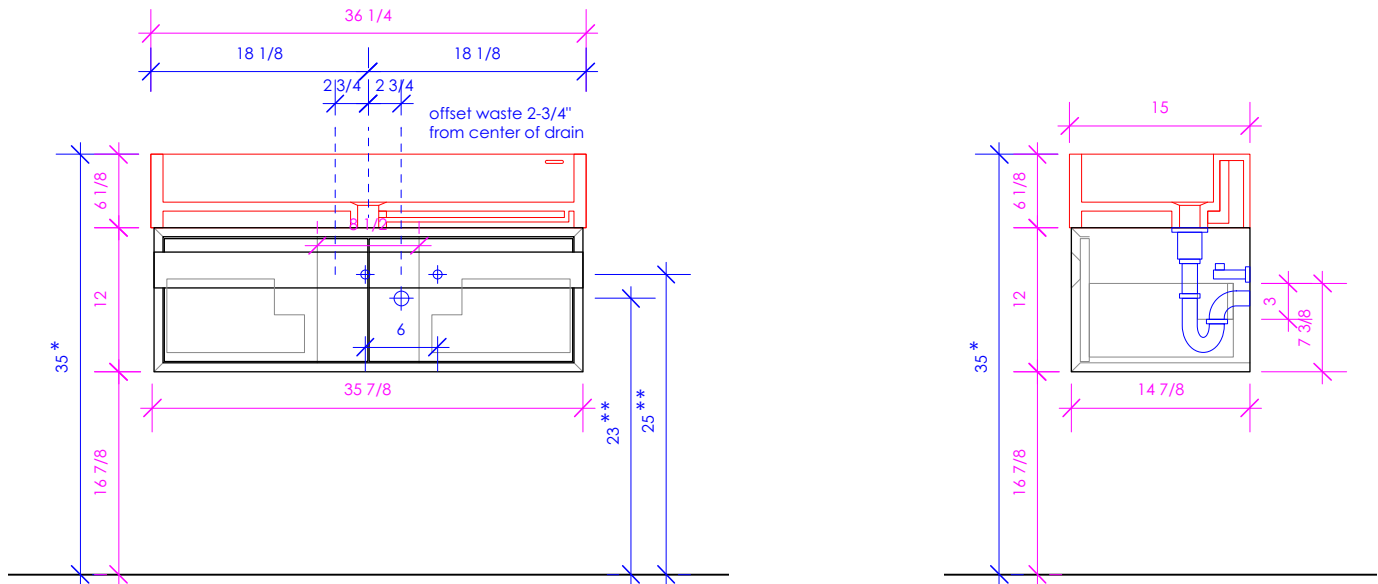

* Recommended installation height
** Recommended plumbing location

FEATURES:

- WALL MOUNT VANITY
- TWO DRAWERS WITH SELF-CLOSE GLIDES
- INTERIOR DRAWERS STAINED TO REFLECT EXTERIOR FINISH
- MITER DETAILING ON EDGES AND DRAWER PULL
- USED WITH 5103 SINK (SOLD SEPARATELY)
- PROUDLY HANDMADE IN THE USA
- MANUFACTURED WITH LOW VOC FINISHES AND WOOD FROM RENEWABLE FORESTS

FINISHES:

WOOD:

STANDARD:

02 - NATURAL CHERRY
07 - NATURAL WALNUT
24 - CLASSIC WALNUT
20 - ASH GRAY
06 - WENGE
33 - AFRICAN MAHOGANY

PREMIUM:

22 - GRAY ZEBRA
31 - WHITE OAK
47 - SMOKY WALNUT
08 - MATTE WHITE
35 - MATTE ARDESIA
54 - MATTE TAUPE
16 - MATTE BLACK

LUXURY:

37 - WEATHERED OAK
52 - SILVER OAK
50 - HORIZON BLUE
85 - GLOSS WHITE
88 - GLOSS ARDESIA
84 - GLOSS TAUPE
86 - GLOSS BLACK
08T1 - WHITE W/ TEXTURE
35T1 - ARDESIA W/ TEXTURE
54T1 - TAUPE W/ TEXTURE
16T1 - BLACK W/ TEXTURE

COUNTERTOP:

STONE:

WH - BIANCO
LN - LINAC
SL - ATHENS
BN - STORM

QUARTZ:

PR - PURO
FS - FOSSIL
AH - ASH
CA - CREMA

SOLID SURFACE:

M - SATIN WHITE
G - POLISHED WHITE

METALS:

METAL:

21 - BRUSHED STAINLESS STEEL
10 - POLISHED STAINLESS STEEL
51 - BRUSHED BRASS
44 - MATTE BLACK

LACAVA reserves the right to revise any dimension or information on this sheet without notice. Dimensions are nominal and may vary within an industry accepted tolerance of 1/4". Cabinets with 'vanity top' sinks are made to the matching sink and dimensions may vary. LACAVA is not responsible for any cutouts, countertops, or furniture made without the actual product or template. Differences in color, grain, appearance, and texture are inherent in all natural woodwork and should be expected. Variances in these qualities are not deemed manufacturing defects and will not be accepted as valid reasons for return or exchanges. Plumbing specifications are only a guideline and may need alteration based on application.

6630 WEST WRIGHTWOOD
CHICAGO, IL 60707

PH: 773-637-9600
FAX: 773-637-9601

LACAVA.COM
INFO@LACAVA.COM