



Location:

3502-CYL-B-TRM, 3502CYLBTRMTC
Tub/Shower Trim
Specification Submittal



Feature Highlights	Options/Modifications
<ul style="list-style-type: none"> • Dia Tub/Shower Trim • Requires Temptrol® Pressure Balancing Tub/Shower Valve • Metal lever handle • 7" diverter tub spout • 1 mode showerhead • 2.5 gpm (9.5 L/min) flow restrictor • Components shall be metal and nonmetallic construction, plated in standard Polished Chrome finish • Available with TA-10 flow control spindle and T-12A cap assembly for Temptrol valve bodies installed with Test Cap (order p/n 3502CYLBTRMTC) 	<ul style="list-style-type: none"> <input type="checkbox"/> -1.5 CG 1.5 gpm (5.7 L/min) flow restrictor <input type="checkbox"/> -2.0 2.0 gpm (7.6 L/min) flow restrictor <input type="checkbox"/> Delete Suffix B Chrome plastic escutcheon on valve with color graphic/indicators in place of standard brass escutcheon <input type="checkbox"/> -EX Exposed column/slide bar, hand shower bracket and hand shower wand (35EX) <input type="checkbox"/> -L1 Less showerhead <input type="checkbox"/> -REB Rebuild trim kit, includes TA-10 and TA-4 <input type="checkbox"/> -SH2 Alternative 352SH-3, 3 mode showerhead <input type="checkbox"/> -SH3 Alternative 362SH Duro showerhead <input type="checkbox"/> -SH4 Alternative 361SH Duro square showerhead <input type="checkbox"/> -SS Slip spout on any tub/shower unit <input type="checkbox"/> -T2 Alternative 361DTS, square diverter tub spout <input type="checkbox"/> -VP Vandal resistant escutcheon screws in place of standard screws <input type="checkbox"/> -BBZ Brushed Bronze finish <input type="checkbox"/> -MB Matte Black finish <input type="checkbox"/> -STN Satin Nickel finish
<p>Model Numbers</p>	
<ul style="list-style-type: none"> <input type="checkbox"/> 3502-CYL-B-TRM Tub/Shower Trim, Temptrol Pressure Balancing Tub/Shower Valve ordered separately <input type="checkbox"/> 3502CYLBTRMTC Tub/Shower Trim with TA-10 flow control spindle and T-12A cap assembly, must order Temptrol valve with Test Cap 	
<p>Compliance</p>	
<ul style="list-style-type: none"> • ASME A112.18.1/CSA B125.1 	
<p>Warranty</p>	<p>Note: Append appropriate -suffix to model number.</p>
<p>Limited Lifetime - to the original end purchaser in consumer/residential installations. 5 Years - for industrial/commercial installations. Refer to www.symmons.com/warranty for complete warranty information. Go to www.symmons.com/register to register your Symmons product.</p>	

Dimensions

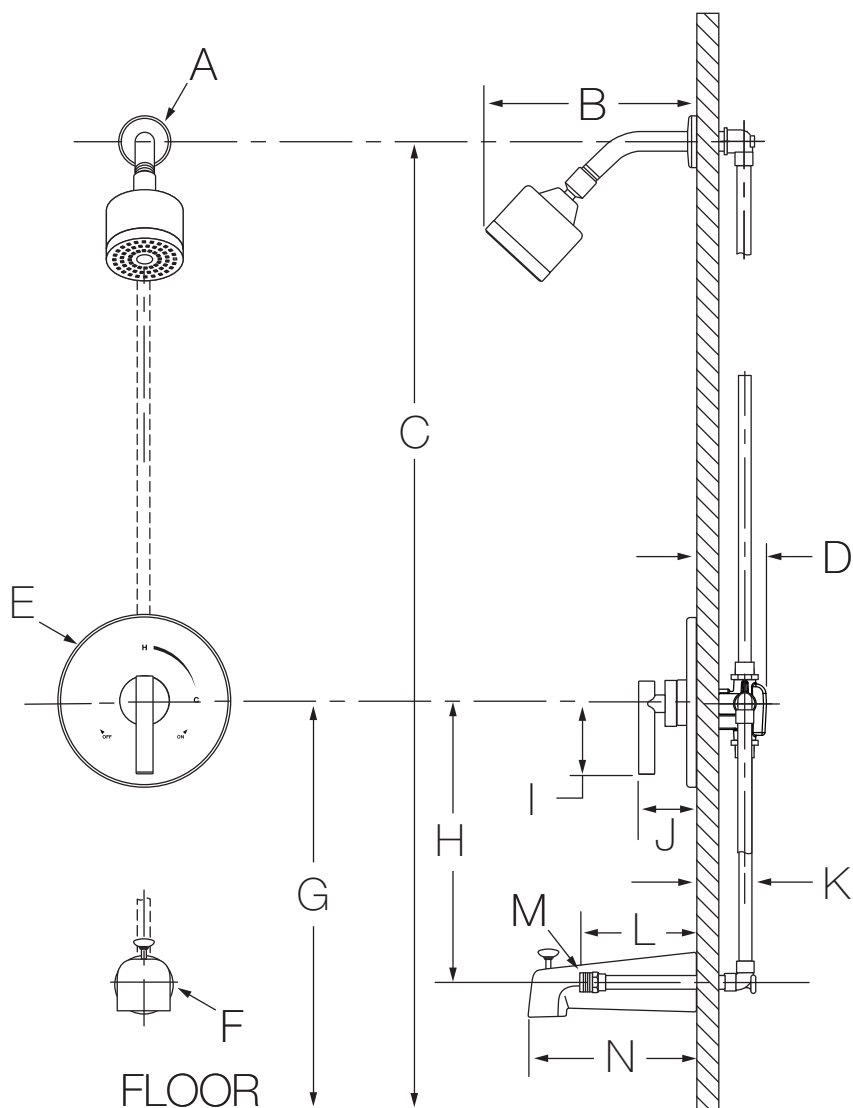

Measurements	
A	Ø 2-1/2", 64 mm
B	6-3/4", 171 mm
C	Ref. 77", 1956 mm
D	3-1/2", 89 mm
E	Ø 7-1/2", 191 mm
F	Ø 2-1/2", 64 mm
G	Ref. 32", 813 mm
H	Ref. 12", 305 mm
I	3", 76 mm
J	2-7/8", 73 mm
K	Rough-in 2-3/8" ± 1/2", 60 mm ± 13 mm
L	5-1/2", 140 mm
M	Male 1/2-14 NPT fitting must protrude 5-1/2" (140 mm) from finished wall
N	7", 178 mm
O	6-3/4", 171 mm
P	6", 152 mm
Q	5-5/8", 143 mm
R	2-1/4", 57 mm
S	2-1/2", 64 mm
T	5/8", 16 mm
U	5-5/8", 143 mm
V	Male 1/2-14 NPT fitting must protrude 4-7/16" (113 mm) from finished wall

-SH2

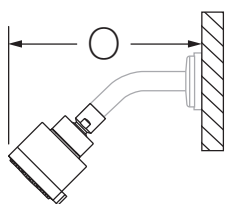

-SH3

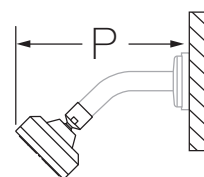

-SH4

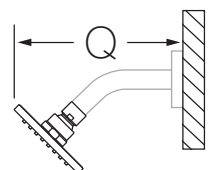
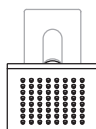

-T2

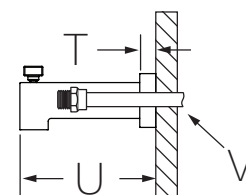
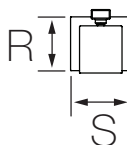

Notes:

- 1) Valve body and piping not included and shown as reference only.
- 2) Plaster shield (p/n T-176) for dry wall, plaster or other type walls 1/2" or greater.
- 3) All dimensions measured from nominal rough-in (see K as reference).
- 4) Dimensions subject to change without notice.